

How to Assemble

InOu Furniture

CRESCENTGARDEN
inou











[Watch the assembly video](#)



[Need help? Contact us](#)

Standard Leg Assembly



	Arm Chair	Lounge Chair / Corner Chair (4 legs)	Ottoman
			
			
	35.2" (90cm)	32.5" (82cm)	26.4" (67cm)

Parts:

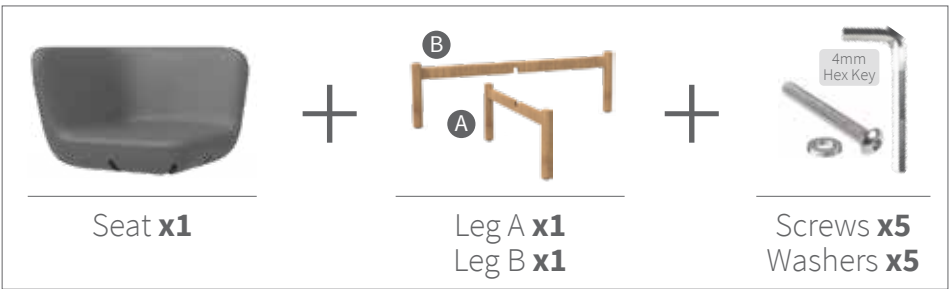

Instructions:

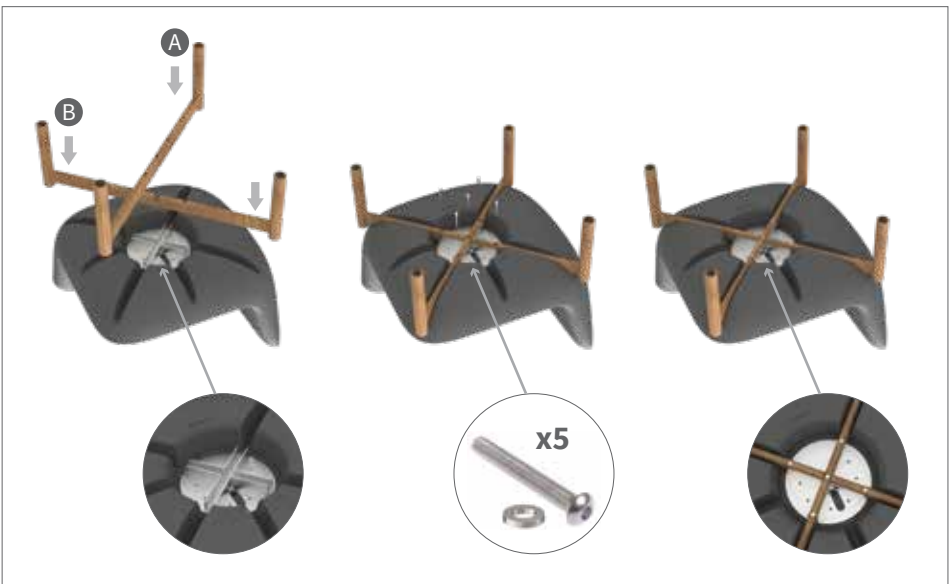

Double-sided Corner Connecting Seat Leg Assembly

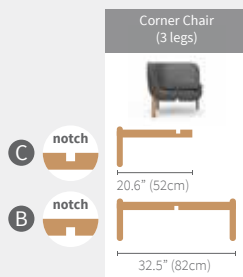

Parts:

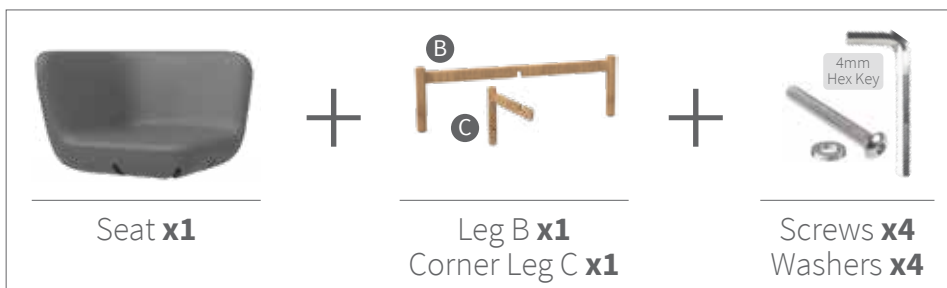

Instructions:

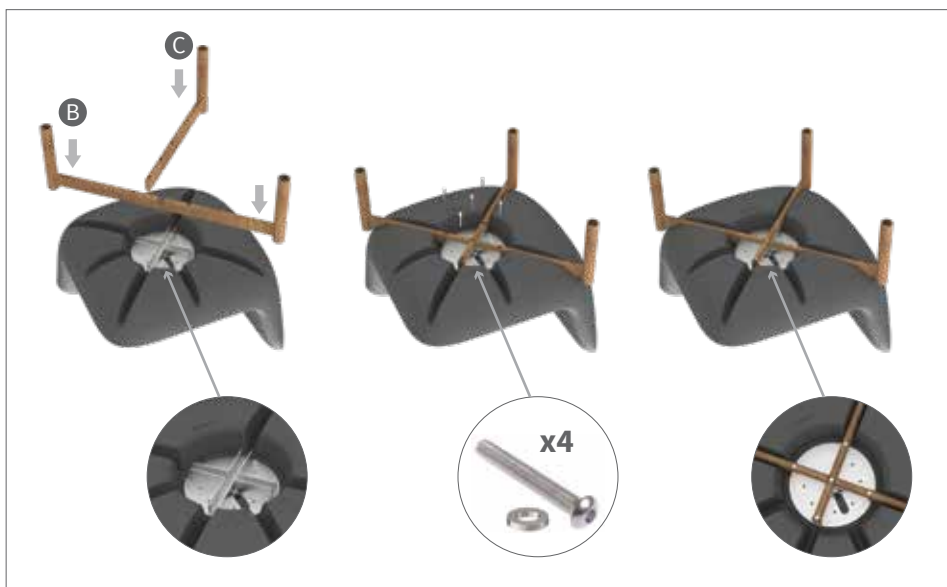

How to connect seats



Parts:



Seat with legs **x2**



Linking Device **x1**

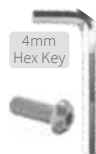

Screws **x4**

Instructions:

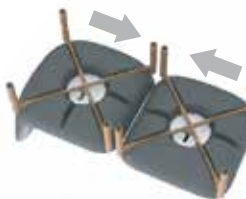

x4



Cushion



Side Table



Powder Coated Steel

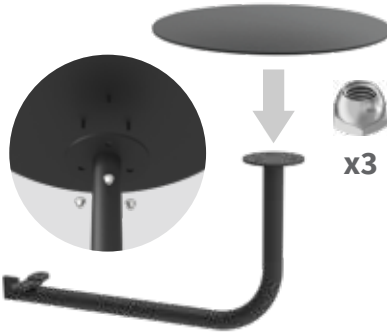

Teak

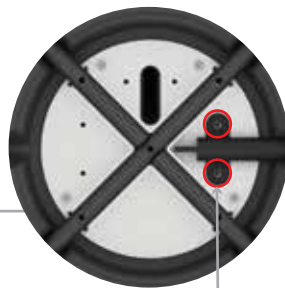

x2

